

sapa:

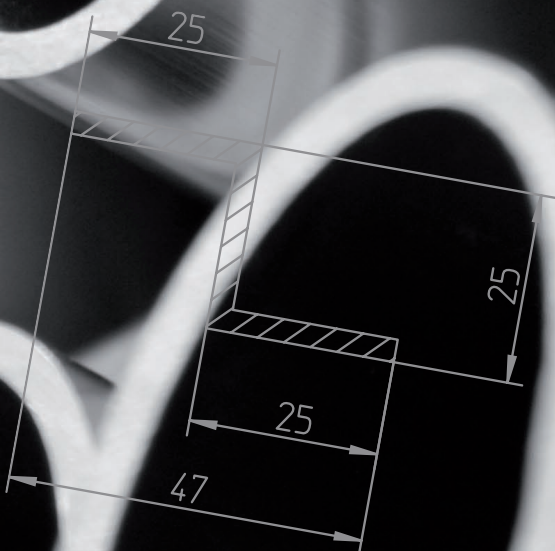
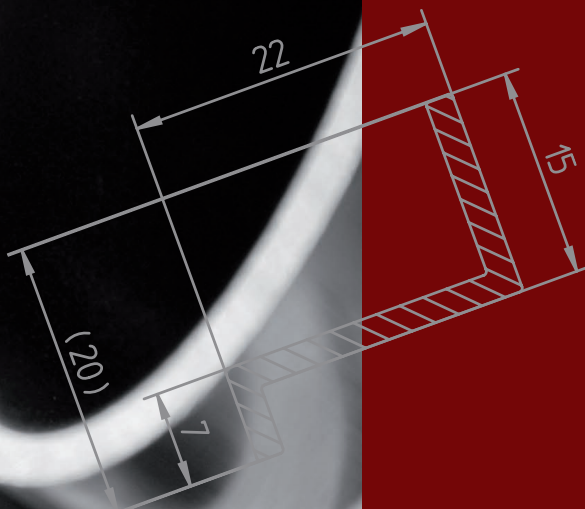
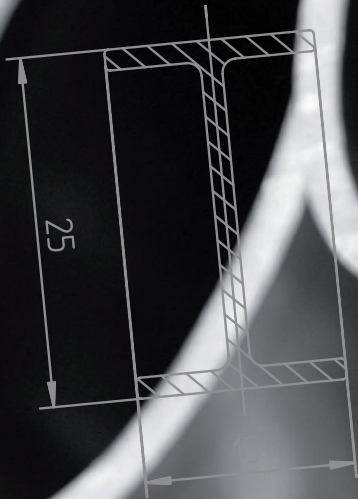

Available dies

Discover the possibilities with
aluminium profiles from Sapa

You can create your own profile or you can choose from a wide selection of standard dies.

Delivery: Mill finished – normally in 4–6 weeks.

Weight: The specified weights are nominal.

Prices etc: Please ask for quotation.

Profile tolerances: Contact us or read more about tolerances in our *Design Manual*. You can order the book or read it at www.sapagroup.com.

Profiles in stock are presented in a separate catalogue.

This catalogue, the catalogue with profiles in stock and more information about our offer is found at our website www.sapagroup.com

The information provided in this catalogue is subject to change.

Sapa Profiles is part of Sapa, which develops, manufactures and markets finished profiles, profile-based building systems and heat exchanger strip in aluminium alloys, and is the leading independent manufacturer in the world.

Sapa's business idea is based on close collaboration with our customers, who are primarily based in Europe, North America and Asia. The largest customer sectors are building, transport, home & office and engineering.

You can find more information at www.sapagroup.com

Available dies

In this catalogue you will find a large number of dies that is available for everyone. It gives you quick access to an economical range of profiles that will fully or partly meet your requirements.

Please remember that you can also create your own ideal profile. Whether you choose a standard profile, a profile from an available die or a tailor-made solution, you get benefits such as low weight, high strength and corrosion resistance.

Aluminium can also be recycled with little additional energy input, which is an important consideration if you are aiming for sustainable development.

Ideas available

Extrusion technology makes it possible to integrate a vast range of different functions into your profile. Among other things this can mean reduced fabrication and easier assembly – hence lower costs. Tooling costs are also very reasonable.

Contact Sapa to discuss your requirements and possibilities.

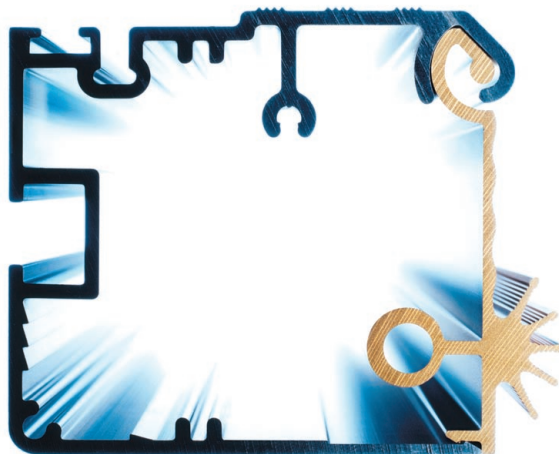

A range of functions can be integrated in the extruded aluminium profile. For example: Screw recess, Lugs, Slots, Reduced thickness to allow spring, Screw markings, Latches, Integral tubes, Heat sink, Decorative pattern, Hinge, Grip surface, Screw recess on projection, Stop for sheet material, Slot for screw or rivet, Slot for rubber seal, "Christmas tree" for joining to wood or plastic, Slot for bolts, etc.

Square bar

Alloy: Sapa 6082-T6 (EN-AW-6082).
Weight (kg/m) = 0.0027 x A² mm (when r = 0).
Surface class = 6.

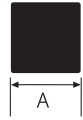

Available dies

Sapa profile no.	Dimensions. mm		Weight kg/m
	B	A	
0776 *	4		0.04
0033 *	6		0.10
0097 *	8		0.17
0086	12		0.39
332367	16		0.69
332689 *	18		0.87
F18542	25		1.69
0037	25		1.69
F18545	27		1.97
F18550	30		2.43
F16133	30		2.42
F27487	32		2.70
F18556	35		3.31
F26488	36		3.48
F26148	38		3.80

Sapa profile no.	Dimensions. mm		Weight kg/m
	B	A	
F35280	41		4.43
F28237	44		5.22
F18568	45		5.47
F12900	46		5.71
F18570	50		6.75
F15912	50		6.69
F26136	53		7.47
F18576	60		9.72
F18173	60		9.71
F18580	70		13.23
F18581	75		15.19

* Alloy 6063-T6

Hexagonal bar

Alloy: Sapa 6082-T6 (EN-AW-6082).
Weight (kg/m) = 0.00234 x A² mm (when r = 0).



Available dies

Sapa profile no.	Dimensions. mm		Weight kg/m
	A		
0042 *	10		0.23
0138 *	11		0.29
F19488	14		0.46
S70957	15		0.53
F19501	17		0.68
F19506	19		0.85
F19509	20		0.93
F19514	21.5		1.09
F19515	22		1.13
F19521	24		1.35
S63500	27		1.71
F19532	28		1.83

Sapa profile no.	Dimensions. mm		Weight kg/m
	A		
F19535	30		2.11
F19539	32		2.40
F19540	32.5		2.47
F19543	34		2.71
F19545	35		2.87
F22864	36		3.03
F19550	38		3.39
F19554	40		3.74
F19571	55		7.08

* Alloy 6063-T6

Rectangular bar

A ≤ 3 mm: Alloy: Sapa 6063-T6 (EN-AW-6063).
A > 3 mm: Alloy: Sapa 6082-T6 (EN-AW-6082). Surface class = 6.
Weight (kg/m) = 0.0027 x B mm x A mm (when r = 0).



Available dies

Sapa profile no.	Dimensions. mm		Weight kg/m
	B	A	
01046	9	6	0.15
0459	10	2	0.06
0238	10	3	0.08
0478 *	10	5	0.14
0877 *	10	6	0.16
0117 *	10	7	0.19
0918 *	10	8	0.22
01083	12	2	0.06
313918	12	3	0.10
S69400 *	12	5	0.16
0099	18	3	0.15
0101	20	2	0.11

Sapa profile no.	Dimensions. mm		Weight kg/m
	B	A	
0586	20	4	0.22
0567 *	20	5	0.26
0587 *	20	6	0.33
0146	20	8	0.43
0467	20	10	0.54
0811 *	20	10	0.54
0260 *	20	10	0.48
R11008 *	22	10	0.58
0151	23	2	0.14
0932	24	8	0.52
0187	25	8	0.54
0176	25	10	0.67

Available dies. rectangular bar (cont.)

Sapa profile no.	Dimensions. mm		Weight kg/m
	B	A	
0214	25	15	1.00
0938	28	3	0.23
332738	30	7	0.57
0243	30	8	0.60
F18874	30	15	1.24
F18876	30	25	2.02
0438 *	32	5	0.52
S60008	34	5	0.46
01050 *	34	16	1.47
0076	35	2	0.19
0170	35	3	0.28
0838 *	35	4	0.38
0223 *	35	5	0.47
S70921	35	7	0.66
F18921	35	8	0.76
F18922	35	10	0.95
F32734	36	20	1.95
F18958	38	6	0.62
F19678	38	35	3.59
0299	40	2	0.22
01029	40	3	0.32
F18985	40	6	0.50
F18986	40	8	0.86
F10179	40	10	1.07
F18988	40	12	1.30
F18990	40	15	1.62
F18996	40	25	2.70
F18997	40	30	3.24
F18999	40	35	3.78
F19023	42	30	3.40
0884	43	3	0.35
S68411	45	2	0.24
0279	45	3	0.36
350168	45	5	0.61
F19038	45	6	0.73
F19046	45	25	3.04
S70964	45	30	3.64
F26989	45	35	4.25
0903	47	2	0.25
0212	50	3	0.41
0177	50	4	0.54
0219	50	6	0.81
F19075	50	7	0.95
S60702	50	8	1.04
F19076	50	8	1.08
313183	50	10	1.35
F19080	50	12	1.62
F19082	50	15	2.03
F19085	50	20	2.70
F19088	50	25	3.38
F19092	50	40	5.40
F19121	55	5	0.74
S69039	55	8	1.19
F42743	55	30	4.46
0075	60	2	0.32
0233	60	4	0.65
F19146	60	8	1.30
F19176	62	12	2.01
0412	65	3	0.53
F19190	65	5	0.88
0660	65	6	1.05
F19192	65	8	1.40
F19194	65	10	1.76
F19197	65	20	3.51
S69903	70	3	0.57
F19208	70	4	0.76
S70962	70	12	2.27
F19212	70	15	2.84
F25402	70	25	4.73

Sapa profile no.	Dimensions. mm		Weight kg/m
	B	A	
F19218	70	35	6.62
F26015	70	45	8.51
0289 *	75	4	0.81
S68902	75	5	1.01
F19233	75	8	1.62
F19235	75	10	2.02
F19237	75	15	3.04
F16974	75	25	5.06
F19257	80	4	0.86
0761	80	5	1.08
F19259	80	6	1.30
F19265	80	30	6.48
F19266	80	40	8.64
F19268	80	60	12.96
F19283	85	20	4.59
S69040	90	5	1.22
F19292	90	6	1.46
F19293	90	10	2.43
F25887	90	17	4.13
F19297	90	20	4.75
F26180	90	25	5.94
F19300	90	70	17.01
F29493	95	5	1.28
S69191	100	3	0.81
F19708	100	5	1.35
F19313	100	8	2.16
F19316	100	15	4.05
F19319	100	25	6.75
F19321	100	40	10.80
F19322	100	50	13.50
F24702	100	60	16.20
F19340	105	50	14.18
0907	110	3	0.89
S69302	110	5	1.49
F19356	120	60	19.44
0788 *	125	6	2.02
F19576	125	40	13.50
0975	140	5	1.89
F19391	140	18	6.80
S64647	150	4	1.62
F19402	150	5	2.02
F19407	150	20	8.10
F19408	150	30	12.15
F19416	155	10	4.18
F19419	160	8	3.46
F28501	160	10	4.32
F19865	160	15	6.48
F19432	175	10	4.72
F19436	180	8	3.89
F19437	180	20	9.72
F19439	185	6	3.00
F19441	190	4	2.05
F19451	225	15	9.11
F24703	250	5	3.38
F19454	250	10	6.75
F19455	250	15	10.12
F28507	250	20	13.50
F19457	300	10	8.10
F19460	300	20	16.20

* Only alloy 6063-T6

Round bar

Alloy: Sapa 6082-T6 (SS 4212-06).
Surface class = 6.
Weight (kg/m) = 0.00212 x D² mm.

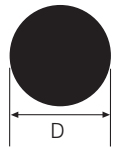

Available dies

Sapa profile no.	Dimensions. mm		Weight kg/m
	D		
0741 *	3	0.02	
0742 *	4	0.03	
0469 *	5	0.05	
0109 *	7	0.10	
0973 *	9	0.17	
320263	11	0.25	
0153 *	13	0.36	
0305	14	0.42	
0039	15	0.48	
0066	18	0.69	
S60482	19	0.77	
0067	22	1.03	

Sapa profile no.	Dimensions. mm		Weight kg/m
	D		
F90068	26	1.43	
0068	28	1.66	
F90089	34	2.45	
F90094	36	2.75	
F90099	38	3.06	
F90111	43	3.92	
F90118	49	5.09	
F90133	61	7.89	
F90202	65	8.96	
F90144	70	10.40	
F90148	75	11.90	

* Alloy 6063-T6

Equal flange L-profiles

A ≤ 3 mm. Alloy: Sapa 6063-T6 (EN-AW-6063).
A > 3 mm. Alloy: Sapa 6082-T6 (EN-AW-6082).
Surface class = 6.

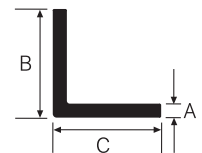

Available dies

Sapa profile no.	Dimensions. mm		Weight kg/m
	B-C	A	
0634	10	1.5	0.08
0453	10	2	0.10
0353	14	2	0.14
0048	15	2	0.15
0050	15	3	0.22
0870	20	1.5	0.16
0392	20	3	0.30
S69030	20	4	0.40
0371	22	3	0.33
0245	25	1.5	0.19
F378	25	2.5	0.32
F412	25	3	0.38
0394	25	3	0.38
0751	25	4	0.50
0103	25	5	0.61
F13753	30	1.5	0.24
S69712	30	2	0.31
0617	30	2	0.32
S70650	30	2	0.32
0740	30	3	0.46
F3323	30	5	0.75
F29140	33	3	0.51
0991	35	3	0.54
0856	35	4	0.71
0213	35	5	0.88
0266 *	35	8	1.34
0965	40	1.5	0.32
F21848	40	2	0.42
01006	40	2.5	0.52
F25559	40	3	0.62
0275	40	3	0.62
0018	40	3.5	0.73
F4668	40	4	0.82
S64651	40	5	1.00
F3303	40	6	1.20
F4669	45	4	0.93
F7334	45	5	1.10
0270	50	2	0.53
F21438	50	2	0.53

Sapa profile no.	Dimensions. mm		Weight kg/m
	B-C	A	
F5849	50	3	0.79
F7711	50	4	1.04
0958	50	5	1.28
F3311	50	7	1.80
0706	50	8	2.00
0654 *	50	8	2.02
0073	60	2	0.65
S69374	60	4	1.30
F25033	60	5	1.57
S70967	60	6	1.85
F26070	60	8	2.42
F3307	60	8	2.40
F27763	60	10	2.99
0185 *	60	12	3.50
F21351	65	8	2.70
F20871	65	9	3.00
0508 *	70	4	1.48
F21524	75	8	3.10
F20806	75	9	3.50
F21649	75	10	4.00
0899	80	2	0.86
F25034	80	5	2.11
F43067	80	8	3.28
0962	90	3	1.43
F27624	90	5	2.36
F3312	90	9	4.20
F23330	100	5	2.60
F26912	100	6	3.14
F21181	100	8	4.20
F26913	100	10	5.13
F3314	100	10	5.20
F7968	110	8	4.60
F21470	125	10	6.50
F9502	130	10	6.80
F25035	152	12	8.52

* Only alloy 6063-T6

Unequal flange L-profiles

A ≤ 3 mm. Alloy: Sapa 6063-T6 (EN-AW-6063).
 A > 3 mm. Alloy: Sapa 6082-T6 (EN-AW-6082).
 Surface class = 6.

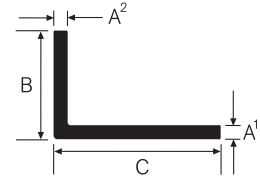

Available dies

Sapa profile no.	Dimensions. mm				Weight kg/m
	B	C	A ¹	A ²	
0925	8.5	6	2		0.07
F22851	12	10	2		0.11
0652	15	7	2		0.11
0186	15	10	1.5		0.10
0051	15	10	2		0.12
0384	18	8	1.25		0.09
0128	18	10	2		0.14
0405	20	5	1.5		0.09
0017	20	10	2		0.15
01012 *	20	10	4		0.28
0474	20	12	1.25		0.11
0267	20	12	2		0.16
314339	20	15	1.5		0.14
0669	22	8.5	2		0.15
S69851	22	12	2		0.17
0427	23	15	3		0.28
0522	25	5	3		0.22
0366	25	9	3		0.25
0232	25	15	1.5		0.16
0315	25	15	2		0.21
0359	25	15	2		0.21
0787	25	20	1.6		0.19
0448	25	20	2		0.23
01024	25	20	3		0.34
0241	27	5	2		0.16
0197	27	9	2		0.18
F17823	27	20	3		0.36
0244	28	6.5	1.25		0.11
0970	28	10	1		0.10
0871	28	20	2		0.25
0418	30	4	1.5		0.13
0294	30	12	2		0.22
0746 *	30	12	4		0.41
0828	30	15	2		0.23
0129	30	15	2		0.23
S70653	30	20	2		0.26
0217	30	20	2		0.26
F3970	30	20	3		0.38
0421	30	20	4		0.50
0376	30	25	2		0.29
0716 *	30	25	5		0.68
0533	32	18	1.5		0.20
0120	32	30	2		0.33
0254	33	25	2.5		0.38
0540	34	12	2		0.24
0127	35	15	1		0.13
0080	35	20	1.5		0.22
S70787	35	20	2		0.29
0896	35	23	3		0.45
0397	35	25	2		0.31
0422 *	35	25	4		0.60
0158 *	35	25	5		0.76
0079	35	30	1.5		0.26
0297	40	10	1.5		0.20
0674	40	15	1.5		0.22
S70041	40	15	2		0.29
S68911	40	15	5		0.68
S68474	40	20	1.5		0.24
0335	40	20	3		0.46
0269 *	40	20	4		0.60
F11677	40	20	5		0.74
320919	40	25	4		0.66
F14976	40	30	2		0.37

Sapa profile no.	Dimensions. mm				Weight kg/m
	B	C	A ¹	A ²	
0555	40	30	3		0.55
0118	40	32	2		0.37
0529	45	12	1.5		0.23
0436	45	20	1.5		0.26
0759	45	25	2		0.37
0169	45	30	3		0.58
0095 *	45	30	4		0.77
0316	48	15	1.5		0.24
01026 *	50	8	4		0.58
S63525	50	15	1.5		0.26
0148 *	50	18	5		0.86
R1968	50	20	2		0.37
0725	50	20	3		0.54
0227	50	25	3		0.59
0752 *	50	25	4		0.77
F28214	50	25	5		0.95
0910	50	30	1.3		0.28
R1539	50	30	2		0.42
348017	50	30	3		0.62
0377	50	35	2		0.45
F4510	50	40	3		0.71
0191 *	50	40	5		1.15
0074	52	17	2		0.37
01043	52	30	6		1.25
0949 *	55	20	5		0.96
F17834	55	40	4		0.99
F13242	55	40	5		1.20
S69970	60	20	2		0.42
S69032	60	25	3		0.66
F25561	60	30	3		0.70
F14157	60	30	4		0.93
F3704	60	30	6		1.40
S71141	60	35	3.5	2.5	0.72
S71199	60	40	4		1.04
F24700	60	40	5		1.30
0597 *	60	50	5		1.42
0763 *	60	50	6		1.71
0753 *	64	40	4		1.08
F21478	65	50	5		1.50
F25487	65	50	8		2.35
0417	70	11.5	1.5		0.32
S70599	70	20	2		0.48
0640	70	25	3		0.75
0576	70	35	2		0.56
0993	70	40	2		0.58
0805	70	50	2		0.64
S69239	70	50	5		1.60
F42281	75	50	6		1.93
F16081	75	50	7		2.30
330278	75	50	8		2.53
0739	80	25	1.8		0.50
0942	80	30	3		0.87
F25562	80	40	3		0.95
0794 *	80	40	4		1.25
F26032	80	40	6		1.85
01033	80	55	8		2.74
S64028	80	61	8		2.87
0727 *	88	35	4		1.30
F16082	90	40	6		2.00
0665 *	90	45	5		1.76
F21019	90	50	6		2.20
F25917	90	65	6		2.41
F5105	100	50	6		2.40

Available dies. unequal flange L-profiles (cont.)

Sapa profile no.	Dimensions. mm				Weight kg/m
	B	C	A ¹	A ²	
F21519	100	50	8		3.10
F25710	100	50	10		3.84
F14792	100	55	5	3.5	1.70
F20632	100	65	6		2.60
F21057	100	65	8		3.40
F21371	100	65	9		3.80
F3339	100	65	10		4.20
F25173	100	75	7		3.20
F7961	100	75	8		3.60
F18387	120	60	8		3.80
F29150	120	80	12		6.32
F30757	130	50	5		2.38
F18192	130	50	8		3.70
F3711	130	65	10		5.10
F21020	130	75	9		4.80

Sapa profile no.	Dimensions. mm				Weight kg/m
	B	C	A ¹	A ²	
F20350	135	20	5		2.00
F41180	147	75	5		2.93
0726 *	150	25	4		1.86
F22311	150	75	9		5.30
F25791	150	100	9.5		6.17
F21526	150	100	10		6.50
F15180	150	100	12		7.80
F28400	175	75	10		6.49
F22814	180	90	6		4.30
F17580	200	100	16		12.30
F22703	275	90	12		11.55

* Only alloy 6063-T6

T-profiles

A ≤ 3 mm. Alloy: Sapa 6063-T6 (EN-AW-6063).
 A > 3 mm. Alloy: Sapa 6082-T6 (EN-AW-6082).
 Surface class = 6.

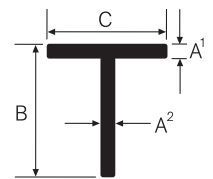

Available dies

Sapa profile no.	Dimensions. mm				Weight kg/m
	B	C	A ¹	A ²	
0435	10	8	1.5		0.07
0924	10	25	3		0.26
0873	15	25	1		0.11
0818	15	30	1.5		0.18
0295	15	35	3		0.38
0503	17	30	2		0.25
0883	17	35	3		0.40
0111	20	20	3		0.30
0100 *	20	25	5	4	0.50
0115	20	30	3		0.39
01000	20	40	2		0.31
S60784	25	25	2		0.26
S69577	25	25	3		0.38
S70965	28	40	3		0.54
0057 *	30	30	4		0.62
F442	30	30	5		0.74
0172 *	30	50	4		0.82
0381	30	60	2		0.48
0891	35	20	3		0.42
0250	35	30	1.5		0.26
0231	35	35	1.5		0.28
0144	35	35	3		0.54
0483	35	40	3		0.59
0749	40	28	3		0.53

Sapa profile no.	Dimensions. mm				Weight kg/m
	B	C	A ¹	A ²	
F3722	40	40	5		1.00
0735	40	50	2		0.48
0472 *	40	60	6		1.60
0936	48	48	2		0.51
0557	50	50	3		0.80
F25405	50	50	5		1.28
F20801	50	50	6		1.60
S70859	50	100	3		1.20
F43575	50	100	10		3.90
0546 *	60	60	4		1.25
F20870	75	50	8		2.60
F10345	100	100	8		4.20
F23394	100	120	15		8.30
F25851	110	100	10		5.40
F29920	140	50	12	6	3.78
F18160	146	50	5		2.70
F28733	147	100	11	4	4.46
F29014	150	60	5	4	2.38
F18161	170	70	15	7	6.00

* Only alloy 6063-T6

U-profiles

A ≤ 3 mm. Alloy: Sapa 6063-T6 (EN-AW-6063).
 A > 3 mm. Alloy: Sapa 6082-T6 (EN-AW-6082).
 Surface class = 6.
 A2 = A1 unless otherwise specified.

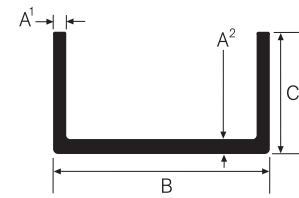

Available dies

Sapa profile no.	Dimensions. mm				Weight kg/m
	B	C	A ¹	A ²	
0511	8	14	1		0.09
0424	10	6	1.5	2	0.09
0584	10	10	1		0.08
0997	10	10	1.5		0.11
0431	10	15	2		0.19
0432	10	20	2		0.25
S70046	12	25	2		0.31
0308	14	9	2		0.15
S69207	14	14	2		0.21
0383	14	18	2		0.25
01013	15	9	2		0.16
0259	15	15	1		0.12
0481	15	15	1.5		0.18
0385	16	4	1.5		0.09
0465	16	24	2		0.32
0202	16	30	2		0.39
0880	17	25	2		0.34
0754	18	15	3		0.34
R149	18	18	2		0.27
311238	18	20	1		0.15
0894	18	20	2.5		0.36
0663	20	10	2		0.21
0318	20	18	1.5		0.21
S70417	20	20	2		0.30
0199	20	25	2.5		0.44
01010	20	30	2		0.41
0135	20	30	3		0.60
S65485	20	32	3		0.67
0779	20	35	3		0.69
0673	20	45	2		0.57
0194 *	22	35	4		0.91
01047	25	12	2		0.24
0494	25	15	1.5		0.21
0701	25	15	2		0.27
S69066	25	15	3		0.40
0664 *	25	18	4		0.58
01003	25	25	2		0.38
0528	25	30	3		0.65
S61791	25	40	2		0.55
0277	25	50	2		0.65
0332	27	17	2		0.31
01021 *	30	10	4		0.45
S69828	30	14.5	1.5		0.23
0937	30	15	2		0.30
0401	30	20	2		0.36
0826	32	20	2		0.37
R11715	30	20	3		0.52
S65334	30	20	5		0.81
S69227	30	30	3		0.68
0253 *	30	40	5		1.36
0901	32	15	2		0.31
0723	33	8	2		0.24
S69779	33	25	1.5		0.32
0321	34	23	3		0.60
0406	34.5	22	2		0.40
S69233	35	13	3		0.44
0825	35	15	2		0.33
0420	35	60	2.5		1.01
R11150	37	25	1.5		0.34
310958	40	8	3		0.42
0143 *	40	20	4		0.80
S61882	40	25	2		0.46
0276	40	40	3		0.92

Sapa profile no.	Dimensions. mm				Weight kg/m
	B	C	A ¹	A ²	
F29887	40	40	4		1.24
S70961	40	40	4		1.23
01008	40	50	2		0.73
0691	45	8	2		0.31
0839	48	10	1.5		0.26
0758	50	15	2		0.42
F22139	50	25	4		0.99
S70651	50	30	2		0.57
0559	50	30	3		0.86
F28357	50	40	4		1.32
F27877	50	50	4		1.53
F24991	50	50	7	5	2.47
322419	50	60	5		2.16
0920	50	100	2		1.31
0623	55	25	2		0.55
0622	55	55	2		0.87
0534	56	24.5	2.5		0.66
0105	56	50	2.5		1.02
01036	60	20	2		0.52
0755 *	60	30	4		1.21
F3342	60	30	4.5	3	1.20
01004	60	40	2.5		0.91
S70160	60	40	4		1.43
0621 *	60	80	4		2.30
0258	65	50	2.5		1.08
F22346	75	20	2.5	5	1.20
F20808	75	40	54		1.80
0906 *	80	30	4		1.43
01005	80	40	3		1.25
0370	80	45	2		0.90
F26498	80	45	6		2.56
0836 *	90	45	3		1.42
F29861	90	60	8		4.20
0532	100	10	2.5	2	0.76
0933	100	30	2		0.84
S68866	100	30	3		1.25
F8664	100	37	5		2.25
F11138	100	50	3		1.60
F35059	100	50	5		2.54
F25449	100	50	6		3.09
F15303	100	50	7		3.50
F3344	100	50	7.5	5	3.20
F20809	100	50	86		3.60
F18038	100	60	7		4.00
F23395	100	80	3		2.10
0627	100	80	3		2.09
F22534	106	63	3		1.80
F20940	110	60	85		3.88
F3349	120	55	108		5.20
F20480	125	65	96		5.00
F24891	130	50	5		3.10
F25946	150	50	10		6.21
F36639	160	60	5		3.67
F17473	160	65	7.5		5.60
F16166	170	80	10		6.77
F17135	200	100	10		10.30
F15498	220	75	14		12.90
F21813	250	75	3		3.20

* Only alloy 6063-T6

I-profiles

A ≤ 3 mm. Alloy: Sapa 6063-T6 (EN-AW-6063).
 A > 3 mm. Alloy: Sapa 6082-T6 (EN-AW-6082).
 Surface class = 6.

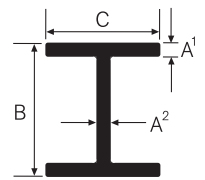

Available dies

Sapa profile no.	Dimensions. mm				Weight kg/m
	B	C	A ¹	A ²	
0772	15	6.5	1		0.08
0833	20	36	2		0.48
0890	20	42	2		0.55
0892	25	15	1.5		0.21
0434	25	28	2		0.42
0886	25	40	3	4	0.85
0312	35	40	2		0.60
0330 *	40	50	5	3	1.60
0849	50	30	2	4	0.82
S69280	50	50	3	2	1.10
F3755	50	50	6	4	2.10
F21146	80	45	7	5	2.60

Sapa profile no.	Dimensions. mm				Weight kg/m
	B	C	A ¹	A ²	
S70966	80	80	5		3.16
F22701	100	80	8	6	5.20
F3758	100	100	10	7	7.00
F17474	140	140	6		6.70
F20694	150	120	8		8.40
F21234	160	80	10		8.33
F17536	160	160	10		12.50
F16152	260	120	12	5	11.50

* Only alloy 6063-T6

Z-profiles

Alloy: Sapa 6063-T6 (EN-AW-6063).
 Surface class = 6.
 A2 = A1. C2 = C1 unless otherwise specified.

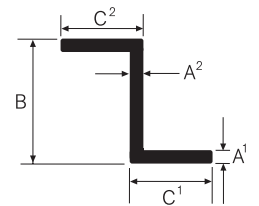

Available dies

Sapa profile no.	Dimensions. mm					Weight kg/m
	B	C ¹	C ²	A ¹	A ²	
0520	9	22	10	2		0.20
59494	12	19.5	14	2		0.22
01018	12	30	18	3		0.44
0502	12.5	28	16	2		0.28
0882	17	10	7	2		0.16
S69461	18	21		2		0.30
0251	18.5	20	13	1.5		0.20
0134	20	20		2		0.30
0698	22	15	7	2		0.22
0133	24	30	20	2		0.38
F16387	25	15		3		0.40
F23218	25	25		3		0.56

Sapa profile no.	Dimensions. mm					Weight kg/m
	B	C ¹	C ²	A ¹	A ²	
S69326	25	32	22	2		0.41
F3770	30	25		4		0.79
0809 *	30	30		5		1.08
0446	36	11		2		0.29
F21410	40	30		3		0.76
0193	45	20		2		0.44
0978	49	33		3		0.88
0626	60	25		3		0.84
0940	77.5	25	22.5	2.5		0.81
0521 *	82	50	26	4		1.62
F21265	100	50		3		1.60
0774	120	20		3		1.25

* Only alloy 6063-T6

Square tube

Alloy: Sapa 6063-T6 (EN-AW-6063).
 Surface class = 5.

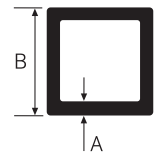

Available dies

Sapa profile no.	Dimensions. mm		Weight kg/m
	B	A	
2395	9	1	0.09
2222	10	1	0.10
2374	15	2	0.28
2654	16	1	0.16
2693	16	1	0.16
2132	16	1.5	0.23
2698	18	1.5	0.27
2458	19	1.5	0.28
2320	20	2	0.39
2321	20	2	0.39
2460	22	1.5	0.33
2574	22	2	0.43

Sapa profile no.	Dimensions. mm		Weight kg/m
	B	A	
2712	25	1.5	0.36
2314	25	2	0.50
2300	25	3	0.71
2117	27	2	0.54
2053	30	2	0.59
2448	30	3	0.89
S64787	30	4	1.10
2489	35	1.5	0.54
2604	35	2	0.71
S68975	35	2	0.70
2301	35	3	1.04
675412	40	2	0.82

Available dies. square tube (cont.)

Sapa profile no.	Dimensions. mm		Weight kg/m
	B	A	
2269	40	2.5	1.01
F43938	40	2.5	1.01
2431	40	3	1.20
S69108	40	4	1.56
2629	40	4	1.56
2176	40	4.5	1.73
2436	41	4.5	1.66
2046	45	2	0.93
2173	50	2	1.04
2207	50	2.5	1.28
2462	50	3	1.52
S70069	50	4	1.99
F9557	50	5	2.43
F14037	50	7	3.20
F23631	50.5	4.5	2.10
S69322	60	2	1.25
2201	60	2.5	1.55
F21440	60	3	1.80

Sapa profile no.	Dimensions. mm		Weight kg/m
	B	A	
F29873	60	4	2.40
322235	60	6	3.50
2540	63.5	3	1.96
F18419	70	3.5	2.50
F26958	70	4	2.85
2638	75	3	2.33
2722	80	3	2.49
F27024	80	3	2.55
F29897	80	5	4.11
F16256	90	3	2.80
F29085	100	5	5.12
F29034	100	6	6.27
F27844	120	5	6.21
F30174	120	9	10.57

Rectangular tube

Alloy: Sapa 6063-T6 (EN-AW-6063).
Surface class = 5.
A2 = A1 unless otherwise specified.

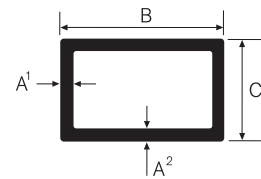

Available dies

Sapa profile no.	Dimensions. mm				Weight kg/m
	B	C	A ¹	A ²	
2054	18	12	1		0.15
2675	18	16	2		0.32
2664	20	12	1		0.16
2451	20	15	1		0.18
S71473	22	18	2		0.38
F21250	25	15	1.5		0.30
2671	25	20	2		0.44
2600	30	9	1.5		0.29
2601	30	12	1.5		0.32
2081	30	12	3	2.5	0.52
2561	30	13	1.5		0.32
2259	30	20	1.5		0.38
S69036	30	20	3		0.71
2670	30	25	2		0.55
2685	31	22	2		0.53
2469	32	15	1		0.25
2229	35	13	2		0.48
S62662	35	17	2		0.52
2669	35	20	2		0.55
2279	35	25	2		0.61
2673	35	25	2.5	1.5	0.58
2661	40	15	2		0.55
F20099	40	20	1.5		0.46
2472	40	20	2		0.60
S69344	40	20	3		0.87
2283	40	28	3		1.00
2666	40	30	1		0.36
2278	40	30	2		0.71
2667	40	30	2		0.70
2474	40	30	2.5		0.85
2672	40	35	2		0.77
2214	42	22	3		0.94
2185	45	20	2		0.66
2203	45	35	2		0.82
2265	45.5	15.5	2		0.62
2572	45.5	25.5	1.5		0.55
2277	48	38	1.5		0.67
2216	48	40	4		1.73
314211	50	10	1.5		0.46

Sapa profile no.	Dimensions. mm				Weight kg/m
	B	C	A ¹	A ²	
2700	50	20	1		0.36
2662	50	20	2		0.71
2569	50	20	2.5		0.88
2583	50	25	2		0.77
2199	50	30	3		1.20
F16792	50	30	3	2	0.96
F20714	50	30	5	3	1.50
2571	50	34	2.5		1.07
2223	50	40	2.5		1.15
F26739	50	40	4		1.77
2573	54	34	1.5		0.69
2072	55	36	2.5		1.16
2071	55	44	2		1.02
2596	60	20	2		0.82
2197	60	22	1.5		0.65
2355	60	25	2		0.88
2247	60	25	2		0.86
2659	60	25	3		1.28
2400	60	25	5	2	1.22
F28829	60	25	8	2.5	1.67
S70803	60	30	2		0.93
330461	60	30	3		1.36
F14175	60	40	3		1.50
2547	60	40	3.5		1.76
F25569	60	40	4		1.99
F27118	60	40	5		2.43
2452	60	40	5	2.5	1.75
F30469	65	24	5	3	1.52
312550	70	15	1.75		0.76
321334	70	25	2		0.98
2356	70	25	2.5		1.22
2392	70	30	2.5		1.28
S70049	70	30	3		1.52
2704	70	35	2		1.09
F11318	70	38	9	3	2.70
2425	70	40	3		1.69
2103	70	45	2		1.20
S65326	70	50	2		1.25
F13153	70	50	5	2	2.00

Available dies. rectangular tube (cont.)

Sapa profile no.	Dimensions. mm				Weight kg/m
	B	C	A ¹	A ²	
2115	70	55	1.5		0.98
S70977	75	50	3		1.89
2268	80	20	2		1.03
F14176	80	40	3		1.80
2689	80	40	4		2.42
2598	80	40	4	2.5	1.84
2524	80	50	2.5		1.69
2432	80	50	4		2.64
F27308	80	50	5		3.24
F10943	80	50	5	2	2.10
2595	90	18.5	2.5	2	1.17
2275	90	30	2		1.24
F16400	90	30	2.5		1.60
S69176	90	30	3		1.80
F27688	90	50	3		2.17
2342	100	21	2.5	2	1.33
F31354	100	30	6		3.96
2368	100	35	2		1.42
2187	100	35	2.5		1.68
F17294	100	40	3		2.20
S70970	100	40	3		2.17
2506	100	45	2		1.53
2118	100	50	2		1.58
312704	100	50	2.5		1.96
F24873	100	50	4		3.07
F26891	100	50	5		3.78
F25301	100	50	6	4	3.52
F14177	100	60	3		2.50
F23436	100	70	4		3.50
2628	100	75	2.5		2.28

Sapa profile no.	Dimensions. mm				Weight kg/m
	B	C	A ¹	A ²	
F17296	100	80	4		3.70
F14660	108	100	3		3.30
F16996	110	65	5.5		4.70
2648	115	20	2		1.45
2581	120	30	2		1.59
F27534	120	40	4		3.28
2526	120	50	3	2.5	2.30
F27687	120	60	3		2.82
F29399	120	60	6		5.45
F24739	120	60	14	6.3	7.95
F25683	120	80	5		5.05
F13769	135	75	6	3	4.50
2536	140	30	3		2.66
F29813	140	60	3		3.15
F28825	140	100	3		3.79
2528	150	25	2.5		2.34
2480	150	30	3		2.82
F16932	150	30	3		2.80
2542	150	35	2.5		2.43
2427	150	50	2.5		2.63
F25004	150	50	3		3.13
F27513	160	90	5		6.48
F25467	200	40	4		5.01
F27823	200	80	7		10.05
F15159	240	50	10	4	7.45

Round tube

Alloy: Sapa 6063-T6 (EN-AW-6063).
Surface class = 5.

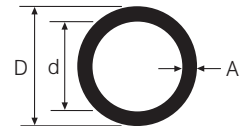

Available dies

Sapa profile no.	Dimensions. mm			Weight kg/m
	D	d	A	
2594	10	5	2.5	0.16
2338	10	6	2	0.14
2067	10	7	1.5	0.11
2209	12	9	1.5	0.13
S70972	13	8	2.5	0.22
2212	13	10	1.5	0.15
2130	13	11	1	0.10
S68872	14	5	4.5	0.36
2679	14	9	2.5	0.24
S69284	15	11	2	0.22
2001	15	13	1	0.12
2047	16	10	3	0.33
2125	16	12	2	0.24
2282	16	14	1	0.13
2184	17	10	3.5	0.40
2050	17	14	1.5	0.20
2323	17	15	1	0.14
S71363	17.5	12.5	2.5	0.32
2038	18	13	2.5	0.33
S70116	18	14	2	0.27
2039	18	15	1.5	0.21
2036	18	16	1	0.14
2029	19	13	3	0.41
2359	19	14	2.5	0.35
2032	19	15	2	0.29
2010	19	17	1	0.15
2362	20	8	6	0.72

Sapa profile no.	Dimensions. mm			Weight kg/m
	D	d	A	
2245	20	10	5	0.63
2264	20	12	4	0.54
2028	20	13	3.5	0.49
2138	20	14	3	0.43
2034	20	15	2.5	0.37
2033	20	16	2	0.31
2423	21	15	3	0.46
2407	21	19	1	0.17
2514	22	12	5	0.72
2059	22	18	2	0.34
2426	22.5	19.5	1.5	0.27
2288	23	19	2	0.36
2348	24	20	2	0.37
2456	25	10	7.5	1.11
S69664	25	15	5	0.85
2055	25	16	4.5	0.78
S69767	25	18	3.5	0.64
2020	25	19	3	0.56
2327	25	20	2.5	0.48
2004	25	22	1.5	0.30
2186	26	21	2.5	0.50
2273	26	23	1.5	0.31
2406	27	21	3	0.63
2218	27	23	2	0.42
2271	27	25	1	0.22
2195	28	18	5	0.97
2172	28	20	4	0.82

Available dies. round tube (cont. 1)

Sapa profile no.	Dimensions. mm			Weight kg/m
	D	d	A	
2525	28	21	3.5	0.73
2088	28	22	3	0.63
S70969	28	24	2	0.44
2550	28	26	1	0.23
2473	29	27	1	0.24
2513	30	12	9	1.60
2410	30	18	6	1.21
2619	30	20	5	1.06
2347	30	22	4	0.88
2094	30	24	3	0.69
2232	30	26	2	0.48
2178	30	27	1.5	0.36
2291	31	25	3	0.71
2558	31	27	2	0.49
2051	32	23	4.5	1.05
2200	32	24	4	0.95
2085	32	25	3.5	0.85
2095	32	28	2	0.51
2370	32	29	1.5	0.39
2429	32	30	1	0.26
F24664	33	14	9.5	1.90
2091	33	25	4	0.98
2364	33	27	3	0.77
2239	33	29	2	0.53
2100	34	25	4.5	1.13
2344	34	26	4	1.02
2089	34	28	3	0.79
2171	35	27	4	1.05
S68977	35	28	3.5	0.93
S68979	35	29	3	0.81
S69477	35	30	2.5	0.69
2297	35	32	1.5	0.43
2461	35	33	1	0.28
2635	36	18	9	2.06
2151	36	26	5	1.31
2610	36	28	4	1.09
2150	36	30	3	0.83
2252	36	32	2	0.58
2024	36	33	1.5	0.44
2005	37	34	1.5	0.45
F19667	38	22	8	2.00
2196	38	25	6.5	1.70
2379	38	30	4	1.15
S60437	38	32	3	0.89
2593	38	33	2.5	0.75
2141	38	34	2	0.61
2433	38	35	1.5	0.47
2175	38	36	1	0.31
2263	39	35	2	0.62
F24862	40	26	7	1.96
S69018	40	33	3.5	1.10
F19636	40	35	2.5	0.79
2180	40	36	2	0.65
2366	40	38	1	0.33
F19949	41	28	6.5	1.90
F19961	41	31	5	1.50
67430	42	15	13.5	3.30
2534	42	28	7	2.08
2096	42	34	4	1.29
2221	42	35	3.5	1.14
S69462	42	37	2.5	0.84
2080	43	34	4.5	1.46
2062	43	39	2	0.69
S64876	43	40	1.5	0.53
2691	44	41	1.5	0.54
F30033	45	25	10	2.97
F29359	45	30	7.5	2.39
2587	45	34	5.5	1.84
F29877	45	35	5	1.70
F26035	45	38	3.5	1.23
2334	45	40	2.5	0.90
2148	45	42	1.5	0.55

Sapa profile no.	Dimensions. mm			Weight kg/m
	D	d	A	
F25808	46	24	11	3.26
2494	47	45	1	0.39
F26064	48	33	7.5	2.58
S68920	48	40	4	1.49
2233	48	44	2	0.78
2690	48	45	1.5	0.59
2139	48	46	1	0.40
2695	49	41	4	1.53
2653	50	35	7.5	2.70
2609	50	39	5.5	2.10
2367	50	40	5	1.95
S63874	50	42	4	1.56
2560	50	43	3.5	1.40
2553	50	44	3	1.20
2591	50	45	2.5	1.01
2376	50	47	1.5	0.62
F41232	51	47	2	0.83
314529	51	48.5	1.25	0.53
F26336	52	34	9	3.28
2390	52	37	7.5	2.85
2124	52	38	7	2.67
2107	52	46	3	1.25
S69676	53	47	3	1.30
F32025	54	34	10	3.72
2026	54	46	4	1.70
2363	54	49	2.5	1.10
2535	54	51	1.5	0.67
F19839	55	43	6	2.50
2274	55	46	4.5	1.92
F19979	55	48	3.5	1.50
2579	55	50	2.5	1.10
2061	55	51	2	0.90
2602	57	47	5	2.20
2246	57	53	2	0.93
F25809	60	40	10	4.24
F25306	60	48	6	2.75
2083	60	50	5	2.34
2508	60	53	3.5	1.68
2097	60	55	2.5	1.22
2341	60	56	2	0.98
2409	60	57	1.5	0.76
2284	61	51	5	2.37
F26821	61	52	4.5	2.16
2158	61	56	2.5	1.24
2235	61	57	2	1.00
2658	62	56	3	1.50
F19983	63	40	11.5	5.00
F19917	63	53	5	2.50
F19982	63	57	3	1.50
S70136	63	58	2.5	1.28
F26822	65	33	16	6.65
F27353	65	55	5	2.54
F19794	65	58	3.5	1.80
2501	65	59	3	1.58
2161	65	62	1.5	0.81
F31775	67	45	11	5.22
2346	68	62	3	1.65
F25307	69	62	3.5	1.94
F25839	70	35	17.5	7.80
F26867	70	54	8	4.21
2412	70	57	6.5	3.50
F26359	70	60	5	2.75
2202	70	62	4	2.24
2676	70	63	3.5	1.97
S60254	70	64	3	1.70
2102	70	65	2.5	1.43
2225	71	60	5.5	3.05
2137	73	58	7.5	4.16
2157	74	69	2.5	1.52
F19739	75	65	5	3.00
2219	75	69	3	1.83
S64774	75	70	2.5	1.54

Available dies. round tube (cont. 2)

Sapa profile no.	Dimensions. mm			Weight kg/m
	D	d	A	
R254	75	71	2	1.24
2255	75	72	1.5	0.93
F25838	76	53	11.5	6.28
2211	76	70	3	1.86
2515	76	71	2.5	1.56
2435	77	73	2	1.28
F19980	78	68	5	3.10
F28202	80	50	15	8.27
F25835	80	60	10	5.94
F34061	80	64	8	4.88
F24735	80	68	6	3.76
F26360	80	70	5	3.18
2258	80	74	3	1.96
S69557	80	75	2.5	1.64
2191	80	76	2	1.30
2496	81	76	2.5	1.69
F19828	82	70	6	3.90
2092	85	75	5	3.39
2339	85	79	3	2.08
2060	85	80	2.5	1.75
2167	85	81	2	1.41
2299	86	78	4	2.78
2153	87	81	3	2.14
2156	88	81	3.5	2.51
2281	88	83	2.5	1.82
2166	89	83	3	2.19
F29316	90	65	12.5	8.21
F31747	90	75	7.5	5.24
2464	90	81	4.5	3.26
F43151	90	83	3.5	2.57
2463	90	85	2.5	1.90
F19838	95	70	12.5	8.74
F24872	95	75	10	7.21
F25309	95	76	9.5	6.89
2564	95	85	5	3.82
F29866	100	70	15	10.81
F19753	100	80	10	7.63
F19733	100	88	6	4.78
F27355	100	94	3	2.47

Sapa profile no.	Dimensions. mm			Weight kg/m
	D	d	A	
F29869	102	75	13.5	10.13
2340	102	95	3.5	2.92
2073	102	96	3	2.52
2701	105	101	2	1.75
F43152	106	100	3	2.62
F26298	108	98	5	4.37
F19736	110	80	15	12.10
F31752	110	87	11.5	9.60
F25408	110	90	10	8.48
F19984	110	100	5	4.50
F42273	114	104	5	4.62
F26702	117	113	2	1.95
F24736	120	104	8	7.60
F19763	120	108	6	6.10
F19799	120	114	3	2.98
F25985	120	115	2.5	2.49
F28515	125	95	15	14.00
F19769	125	111	7	7.00
F19713	125	112	6.5	6.50
F25646	125	115	5	5.10
F19779	125	117	4	4.10
F19862	130	122	4	4.27
F25947	140	132	4	4.61
F19675	140	134	3	3.50
F25394	150	120	15	17.80
F19802	150	140	5	6.15
F19780	150	142	4	5.00
F19800	150	144	3	3.70
F27773	160	140	10	12.72
F24737	160	148	6	7.84
F25470	160	150	5	6.57
F24901	162	150	6	7.94
F19781	175	165	5	7.20
F19717	184	157	13.5	19.50
F24738	200	184	8	13.03
F26114	250	236	7	14.43

Aluminium strip for tiles

Available dies

Alloy: Sapa 6063-T6 (EN-AW-6063).
Surface class = 5.

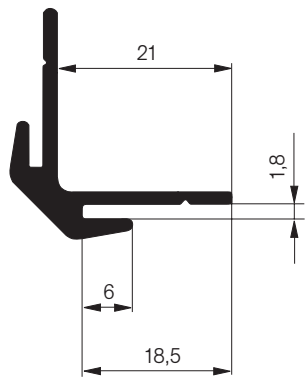

3888 0.29 kg/m

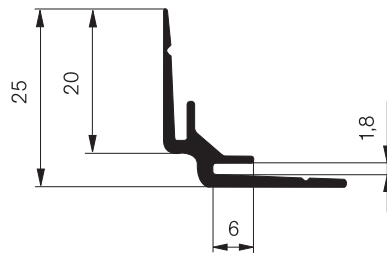

3889 0.21 kg/m

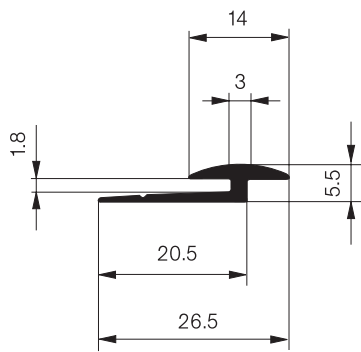

3890 0.14 kg/m

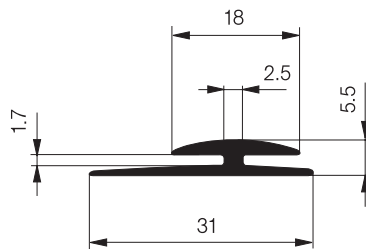

3256 0.19 kg/m

Glazing profiles

Available dies

Alloy: Sapa 6063-T6 (EN-AW-6063).
Surface class = 5.

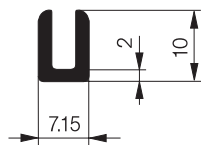

3434 0.13 kg/m

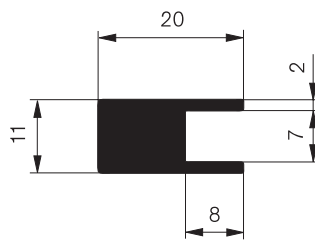

34138 0.44 kg/m

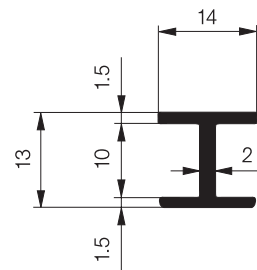

0648 0.17 kg/m

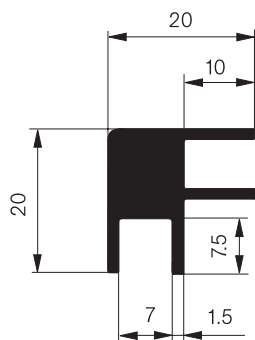

3455 0.48 kg/m

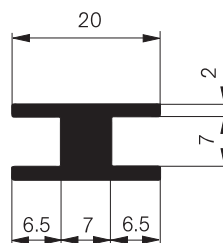

35472 0.35 kg/m

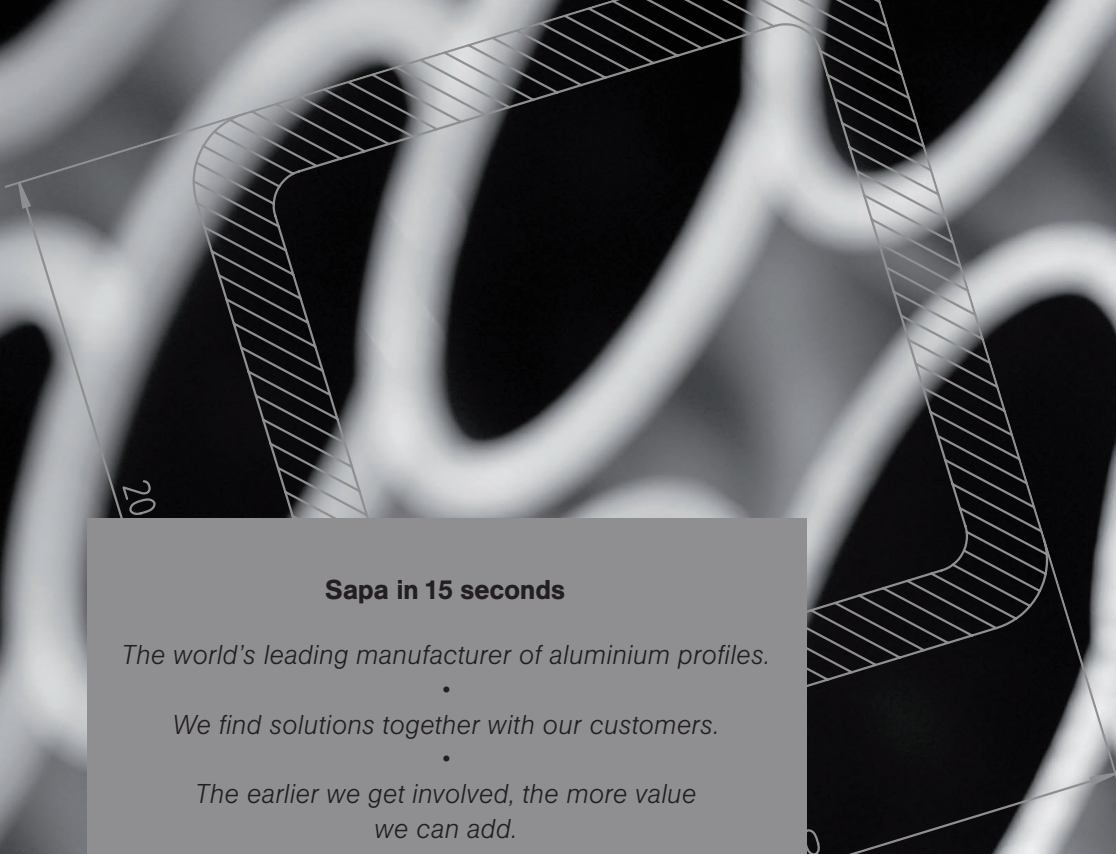

Sapa in 15 seconds

The world's leading manufacturer of aluminium profiles.

We find solutions together with our customers.

The earlier we get involved, the more value we can add.

We aim to become a vital part of our customers' supply chain.

We have a vast experience based on thousands of successful projects.

We and our customers benefit from the excellent properties of aluminium.

Profiles provide unique opportunities when shape and design are key aspects.

We constantly strive to reduce the time it takes to go from idea to finished product.

